

InstaShade



Aurora
Fact Sheet

InstaShade Aurora



The Aurora Cantilever Parasol epitomises elegance and practicality, offering a lightweight, compact design crafted for effortless use. Its 360° rotation and unlimited tilt positions ensure maximum shade coverage, including protection from low afternoon sun, while its space-saving structure eliminates the need for a central post. Built to last with marine-grade materials, the Aurora is easy to install, disassemble, and store, folding neatly against the mast for convenience. The water-repellent, UV-resistant canopy comes in five standard colours, with an extensive range of bespoke options available upon request. Complete with a free cover bag, this parasol is the perfect blend of sophistication and functionality for luxurious outdoor living.



10 Year Fade Warranty

European made 100% solution-dyed colours our premium marine-grade fabric comes with a 2 year fabric warranty & a 10 year colour fade warranty (limitations apply).

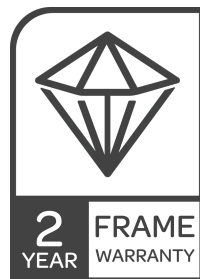

2 Year Frame Warranty

Made with a marine grade aluminium frame and strong stainless steel components & fixings. This is built to last and comes with a 2-year back-to-base frame warranty.



50km/h Wind Rating

Extremely sturdy and robust - able to withstand up to 50 kmph winds.

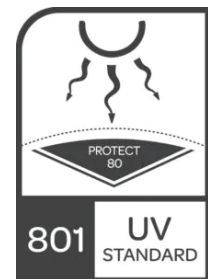

801 UV Standard

Provides Unparalleled sun protection with UV standard 801 certification.

InstaShade Aurora



Marine Grade Aluminium
Frame



Easy Winding Handle



Easy Rotational Lock Handle

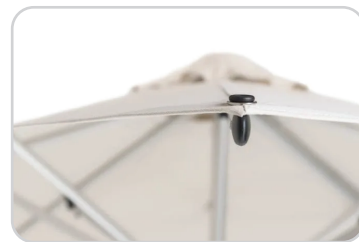

Wind Resistant Up to 50kmph

Key Features

- Maximise shade coverage with flexible 360° rotation
- Block out low afternoon sun with unlimited tilt positions
- Space-saving design with no central post
- Built for longevity, using marine-grade materials
- Easy to install and disassemble, with an optional movable base
- Folds neatly against the mast for compact storage
- Water-repellent and UV-resistant canopy
- Free cover bag

InstaShade Aurora



Stainless Steel Base Plate Upgrade



Stabilizer Bar Kit



Aurora and Eclipse Wheeled Freestanding Parasol Base

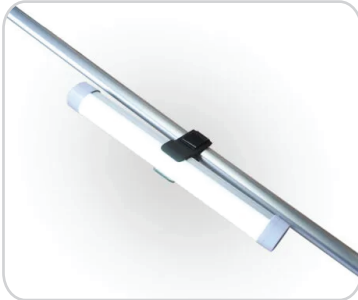

LED Parasol Lighting (Rechargeable)

InstaShade Aurora

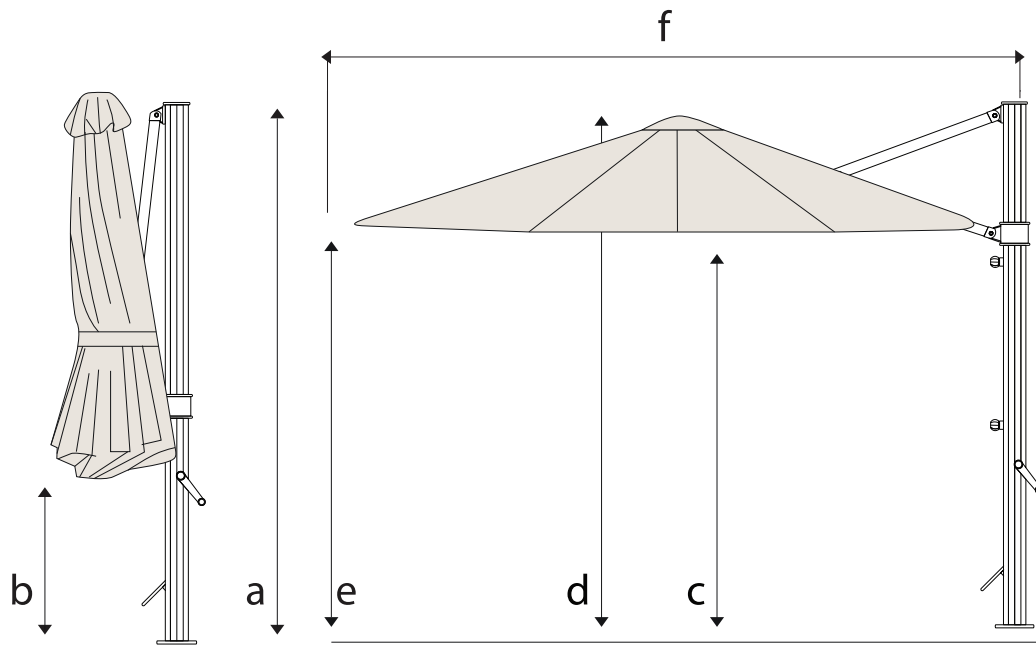

Dimensions

Measured from point to point. All measurements are rounded and are subject to change. Wind damage is not covered by the warranty.

3.5m Octagonal

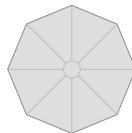

2.8m Square



2.5m Square



Dimensions of Closed Parasol

a: Mast Height (cm)	282	282	280
b: Distance from Arms to Ground (cm)	100	76	96
Weight of Parasol when Folded (kg)	27	27	26

Dimensions of Open Parasol

c: Height to Canopy Hub (cm)	200	210	198
d: Total Height to Top of Canopy (cm)	264	274	254
e: Height to Edge of Canopy (cm)	210	215	189
f: Distance from Outside Edge of Mast to Outside Edge of Canopy (cm)	360	310	280
Width of Canopy (cm)	350	280	250

Weight & Packing Dimensions

Package Dimensions (inc post) (cm)	290 x 47 x 27	290 x 47 x 27	290 x 47 x 27
Weight of Parasol when Packaged in Carton with Spigot (kg)	39	39	39

Wind Rating Guide

Installed Wind Rating	50kmph	50kmph	50kmph
Free Standing Base Wind Rating	30kmph	30kmph	30kmph

Colours



Smoked Tweed



Pistachio



Slate



Natural

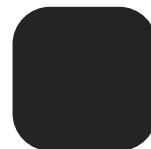

Black

InstaShade Aurora

Aluminium (Standard)

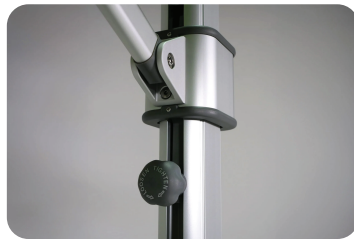

Wood Effect Frame (Optional)

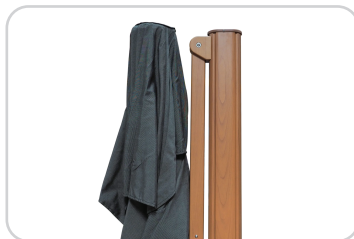
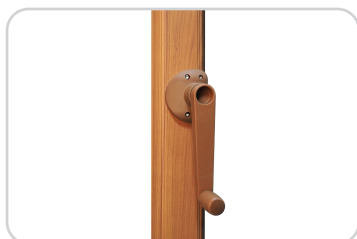

Base Options

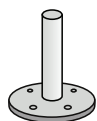

Spigot Included

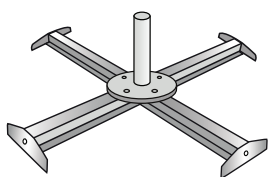

Cross Base

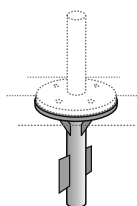

In Ground Fitting - to be
concreted into ground

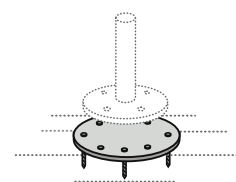

Base Plate 315mm Ø - to bolt
to concrete patio or
wooden deck